

串口接口（蓝牙）

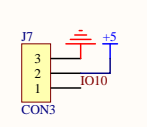

舵机接口

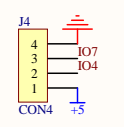

超声波接口

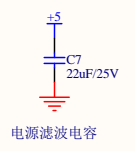

电源滤波电容

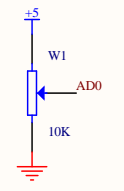

主电位器

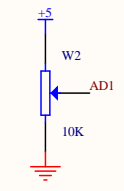

辅助电位器

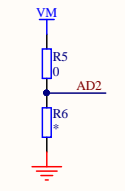

电池电压检测

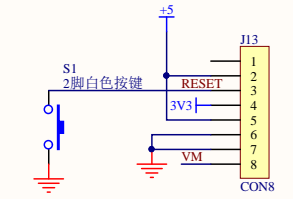

复位按键

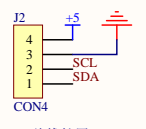

IIC总线扩展口

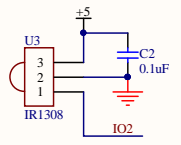

一体化红外接头

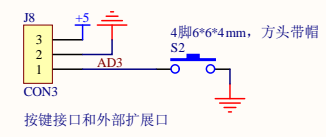

按键接口和外部扩展口

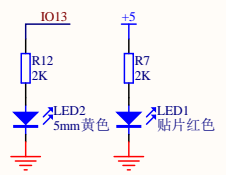

用户灯 电源灯

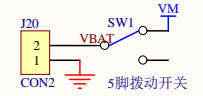

电池插座及开关

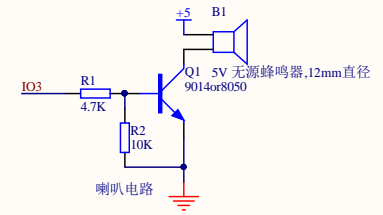

喇叭电路

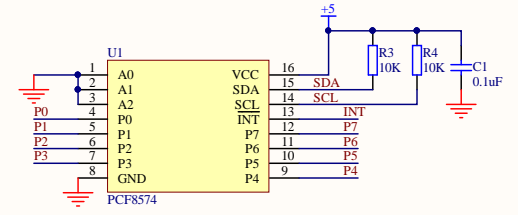

端口扩展芯片

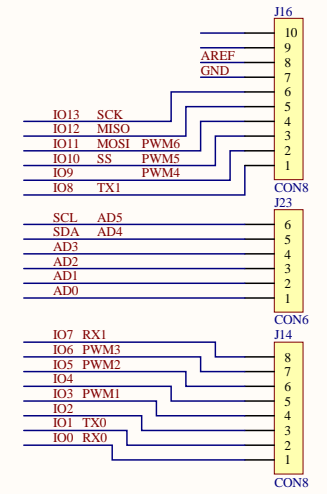

STBY 'L' = standby/200 kΩ pull-down at internal

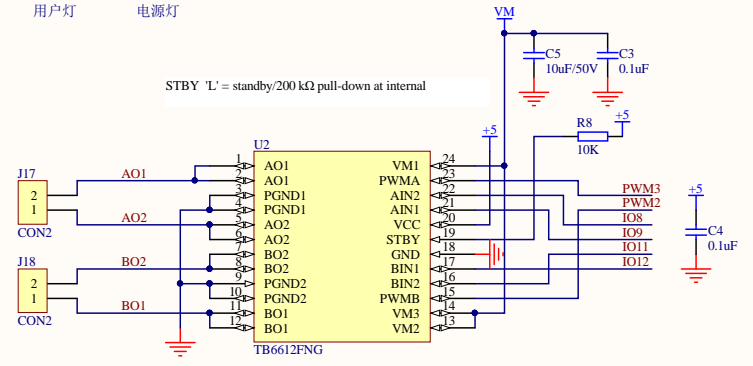

电机驱动芯片

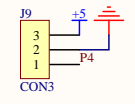

额外扩展口（使用PCF8574后四个口）

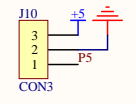

额外扩展口（使用PCF8574后四个口）

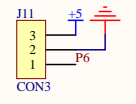

额外扩展口（使用PCF8574后四个口）

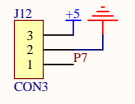

额外扩展口（使用PCF8574后四个口）

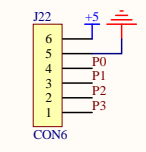

循迹模块接口（使用PCF8574前4个口）

关注“朗译科技”微信号，获取更多资讯
微信号：langyidianzi

品牌： 德飞莱	网址： www.doflye.net
公司：朗译电子科技	
型号： LY-RS003	
比例：1:1	日期：2016-03-06
版本：V1.0	页数：1/1